

B



38



4000K



25 000h

## General Data

Article No.	44225345
Kod	RL-RNP70 740/C/E27 EM
Product EAN	4008597253454
Box quantity (pcs.)	6
EAN Box	4008597453458
Gross weight of box in kg	2.87
Length of box in m	0.237
Width of box in m	0.171
Height of box in m	0.255
Product weight	145 g
Product status	<span style="color: red;">●</span> Nieaktywne

## Electric Parameters

Wattage	38.0 W
Nominal power	38.0 W
Weighted energy consumption in 1000 hours	38 kWh
Nominal voltage	220-240 V
Voltage type	AC

## Electric Parameters

Nominal current	165 mA
Nominal current (mA)	165 mA
dimnable	Nie

## Light Application Parameters

Luminous flux	7500 lm
Rated luminous flux according to IEC 62612	7500 lm
Beam angle	330 °
Efficacy / Luminous efficiency	197.4 lm/W
Color temperature	4000 K
Color coordinate X	0.385
Color coordinate Y	0.393

## Service Life

Average life	25000 h
Mean service life	25000 h
Min. number of switching cycles	15000

## Specification

Energylabel (G -> A)	B
Diameter	46 mm
Length max.	223 mm
Length	223 mm
Burning position	any
Material	Glass
Photobiological safety according to EN 62471	RG1
Lamp shape	Pear-shape
Base	E27
Colour	White

## Notes on Operation

Degree of protection (IP)	IP20
Burning position	any
Mode of operation	CCG, 230V
Ambient temperatures	-20...+40 °C
With movement sensor	Nie

**Information especially for EPREL**

Lighting technology	LED
Mains/Non mains connectable	MLS
Directional or non-directional light	NDLS
Color tunable light source	Nie
Type of color temperature	SINGLE_VALUE
Color stability MacAdams EPREL	6
Life factor EPREL	0.9
Lumen maintenance EPREL	0.96
Flicker	1.0
Stroboscopic effect	0.4
EPREL ID number	2376539

**Notes**

LED lamp for exchange with sodium lamps (HPS), non-dim. Operation with ballast (1:1 replacement) or without (with 230V). No UV or IR radiation.

Please, refer to [www.radium.de/recycling](http://www.radium.de/recycling) for notes on disposal of burned-out lamps as well as lamp breakage.

The "lifespan L70" described for LED lamps indicates the number of hours when the luminous flux has decreased to 70% of its initial value.

The optimal field 'info about service life' contains the frame conditions according to standards based on which the specific service life has been determined. So, for example, "12B50, 50Hz" means that the mean service life (B50) has been determined with a 12h switching cycle at mains (frequency 50Hz), "3B50, HF" is based on a 3h switching cycle at electronic control gear (high frequency).

**Spectrum**

As daylight is a mixture of direct sunlight and light from the sky, the spectral distribution changes all the time due to the time of the day and the weather. The standard illuminant D65 corresponds to daylight with colour temperature of about 6500K.

The colour of coloured LEDs depends on the chemical elements within the light generating chip. The coloured light is generated directly and does not need filtering.

White LEDs are either RGB (red + green + blue chip in one LED = light colour white) or blue LED-chips with yellow/orange phosphor in the resin.

Visible region from 380 to 780 nm; height of graph corresponding with relative spectral emission (400mW/klm)per 10nm.

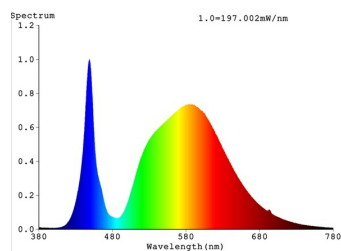

LED retrofit lamps 4000K

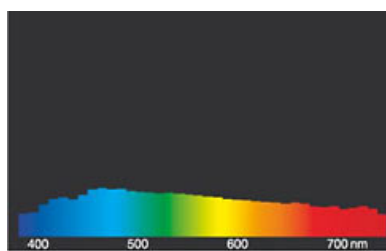

daylight(D 65)

**Special features**



**General notes**

For LED replacement of halogen and incandescent lamps, we recommend direct replacement (1: 1) at the respective burning position. For new systems, the number of lamps in the circuit operated at control gear such as transformers or dimmers can be obtained from corresponding compatibility lists (if available). If there is no specification for the type of device or lamp required, for safety reasons, the replacement power shall be assumed as that of the original halogen type (eg "RL-MR16 35" -> 35W, independent of the real power consumption).

# LED Essence Sodium RNP / NAV-Retrofit

RL-RNP70 740/C/E27 EM

**Radium**

The technical design data in accordance with DIN and IEC. The producer does not take any responsibility for damage to persons or property in case of unsuitable operation or handling of the product. Operating data and dimensions are valid within the usual tolerances. Related lamp types (different bases, mains voltages) may be available on request. Sale and delivery are effected in accordance with the Radium Terms of Delivery and Payment valid on the day of conclusion of contract. Packing units offer economical advantages to the purchase and logistic department. Please match your quantity volume accordingly. For orders of a minimum quantity (clefts) with a lamp model the amount lower than the volume of each packaging unit, we will invoice 10 % additional charge per lamp type. Technical changes and terms of delivery are reserved. Manipulation of any kind to packaging or product is not permissible as this will violate Radium brand rights. Furthermore, technical properties of the product can change to its disadvantage or even destruction. Therefore, Radium cannot be responsible for consequential damages.

® = Registered trademark

Subject to change without notice. Errors and omissions excepted.

## Safety instructions

To ensure full light efficiency and product life, the permissible temperature ranges must be observed and dry environment ensured. When operated with existing control gear, their compatibility with the lamp must be checked.

All technical data without guarantee.