

High pressure sodium lamp

RNP-T/LR 600W/S/230/E40

Radium

Product Datasheet Date: 05.06.2026



A++



90000



2000K



32 000h



Dimmable

General Data

Article No.	34411907
Kod	RNP-T/LR 600W/S/230/E40
Product EAN	4008597119071
Box quantity (pcs.)	12
EAN Box	4008597419072
Gross weight of box in kg	2.828
Length of box in m	0.266
Width of box in m	0.218
Height of box in m	0.343
Product weight	187 g
Product status	● Aktywne

Electric Parameters

Wattage	615.8 W
Lamp nominal wattage	600 W
Weighted energy consumption in 1000 hours	660 kWh
Lamp voltage	110 V
Mains voltage	230 V

Electric Parameters

Ignition voltage	3.6 up to 5.0
Lamp's nominal current	6.06 A
Nominal choke current	6.2 A
Compensation capacitor for 50Hz operation	65 μ F
Running up current max.	125%
Fuse	Delay-action; min. double nominal current
dimnable	Tak
Controllable (in suitable circuit)	up to 50% (Run up at nominal power)

Light Application Parameters

Luminous flux	90000 lm
Rated lamp luminous flux	90000 lm
Efficacy / Luminous efficiency	150 lm/W
Total mains efficacy	139 lm/W
Colour temperature	2000 K
Color rendering index	25
Lumen maintenance at 2000h	0.98
Lumen maintenance at 4000h	0.97
Lumen maintenance at 6000h	0.96
Lumen maintenance at 8000h	0.95
Lumen maintenance at 12000h	0.94
Lumen maintenance at 16000h	0.94
Lumen maintenance at 20000h	0.94

Service Life

Average life	32000 h
B5 - Service life 5% failures	20000 h
B10 - Service life 10% failures	24000 h
Lamp survival factor at 2000h	0.99
Lamp survival factor at 4000h	0.99
Lamp survival factor at 6000h	0.98
Lamp survival factor at 8000h	0.98
Lamp survival factor at 12000h	0.97
Lamp survival factor at 16000h	0.96
Lamp survival factor at 20000h	0.95

Specification

Energylabel notice	no Label needed (> 82.000 lm)
Energylabel (E -> A++)	A++
Diameter	47 mm
Length	285 mm
Total length max.	285 mm
Burning position	h180
Mercury content	19.6 mg
Lamp shape	Tube, single-ended
Model	Clear
Base	E40

Notes on Operation

Burning position	h180
------------------	------

Information especially for EPREL

Energylabel notice	no Label needed (> 82.000 lm)
--------------------	-------------------------------

Notes

High pressure sodium lamp long run (4Y), tubular bulb clear, base E40. Operation with ballast and ignitor.

Please, refer to www.radium.de/recycling for notes on disposal of burned-out lamps as well as lamp breakage.

The "lifespan L70" described for LED lamps indicates the number of hours when the luminous flux has decreased to 70% of its initial value.

The optimal field 'info about service life' contains the frame conditions according to standards based on which the specific service life has been determined. So, for example, "12B50, 50Hz" means that the mean service life (B50) has been determined with a 12h switching cycle at mains (frequency 50Hz), "3B50, HF" is based on a 3h switching cycle at electronic control gear (high frequency).

Base



E40
IEC/EN 60061-1
sheet 7004-24-6

Spectrum

Natural daylight is a mixture of direct sunlight and the light of the sky. Therefore, its spectral composition changes permanently due to the changing time of day. The standardised light classification D65 corresponds to a daylight with a colour temperature of approximately 6500 K. Every discharge lamp type has got an individual spectral power distribution according to its chemical filling. From this result important properties light colour or colour rendering. Sodium vapour lamps are very economic, due to the yellow light RNP lamps have got a high luminous efficiency but only modest colour rendering.

After the lamp start a high pressure sodium lamp needs about 6-10 minutes time to reach its full luminous flux.

Visible region from 380 to 780 nm; height of graph corresponding with relative spectral emission (400mW/klm)per 10nm.

High pressure sodium lamp

RNP-T/LR 600W/S/230/E40

Radium



RNP Standard/Super



daylight(D 65)

Circuit diagram(s)



Standard circuit HID with external ignitor

Key:

L. = lamp

VG = electromagnetic ballast (KVG/VVG)

P = phase

N = zero potential

K = p. f. correction capacitor

Z = ignitor

The required control gear (here ignitor and ballast) for the lamps operation is usually mounted in the suitable luminaire in an appropriate electric circuit. Changes of any kind are to be conducted by qualified and specialised staff, only. Thus, this circuit example is to be understood merely as a technical background information for interested users.



ECG-operation

Key:

L. = lamp

EVG = electronic ballast

P = phase

N = zero potential

The required control gear (here electronic ballast) for the lamps operation is usually mounted in the suitable luminaire in an appropriate electric circuit. Changes of any kind are to be conducted by qualified and specialised staff, only. Thus, this circuit example is to be understood merely as a technical background information for interested users.



ECG-operation

Key:

L. = lamp

EVG = electronic ballast

P = phase

N = zero potential

The required control gear (here electronic ballast) for the lamps operation is usually mounted in the suitable luminaire in an appropriate electric circuit. Changes of any kind are to be conducted by qualified and specialised staff, only. Thus, this circuit example is to be understood merely as a technical background information for interested users.



ECG-operation

Key:

L. = lamp

EVG = electronic ballast

P = phase

N = zero potential

The required control gear (here electronic ballast) for the lamps operation is usually mounted in the suitable luminaire in an appropriate electric circuit. Changes of any kind are to be conducted by qualified and specialised staff, only. Thus, this circuit example is to be understood merely as a technical background information for interested users.

Special features

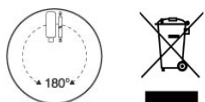

General notes

The technical design data in accordance with DIN and IEC. The producer does not take any responsibility for damage to persons or property in case

High pressure sodium lamp

RNP-T/LR 600W/S/230/E40

Radium

of unsuitable operation or handling of the product. Operating data and dimensions are valid within the usual tolerances. Related lamp types (different bases, mains voltages) may be available on request. Sale and delivery are effected in accordance with the Radium Terms of Delivery and Payment valid on the day of conclusion of contract. Packing units offer economical advantages to the purchase and logistic department. Please match your quantity volume accordingly. For orders of a minimum quantity (clefts) with a lamp model the amount lower than the volume of each packaging unit, we will invoice 10 % additional charge per lamp type. Technical changes and terms of delivery are reserved. Manipulation of any kind to packaging or product is not permissible as this will violate Radium brand rights. Furthermore, technical properties of the product can change to its disadvantage or even destruction. Therefore, Radium cannot be responsible for consequential damages.

® = Registered trademark

Subject to change without notice. Errors and omissions excepted.

All technical data without guarantee.