

Compact fluorescent lamp Ralux®Quick

RXP-Q 11W/827/E27

Radium

Product Datasheet Date: 30.04.2026

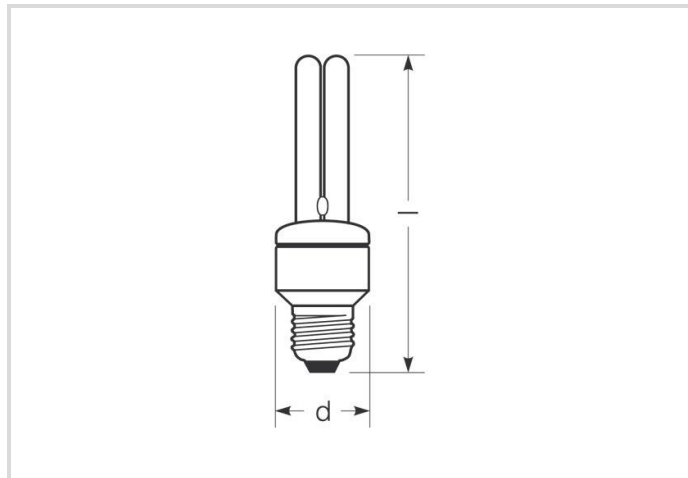

A



620



2700K



15 000h

General Data

Article No.	31918978
Kod	RXP-Q 11W/827/E27
Product EAN	4008597189784
Box quantity (pcs.)	10
EAN Box	4008597489785
Gross weight of box in kg	0.861
Length of box in m	0.24
Width of box in m	0.1
Height of box in m	0.14
Product status	● Nieaktywne

Electric Parameters

Wattage	11.0 W
Power factor	≥ 0.55
Lamp voltage	220-240 V
Mains voltage	220-240 V
Nominal current (mA)	110 mA
dimnable	Nie

Light Application Parameters

Luminous flux	640 lm
Rated lamp luminous flux	620 lm
Efficacy	58.18 lm/W
Light colour	Intra
Code of light color	827
Colour temperature	2700 K
Color rendering index	80-89

Service Life

Average life	15000 h
No. switching cycles	500000

Specification

Energylabel (E -> A++)	A
Diameter	45 mm
Length	120 mm
Total length max.	129 mm
Mercury content	1.3 mg
Lamp shape	Straight
Base	E27

Miscellaneous

EU Directive	DIM1
--------------	------

Notes

Please, refer to www.radium.de/recycling for notes on disposal of burned-out lamps as well as lamp breakage. The "lifespan L70" described for LED lamps indicates the number of hours when the luminous flux has decreased to 70% of its initial value. The optimal field 'info about service life' contains the frame conditions according to standards based on which the specific service life has been determined. So, for example, "12B50, 50Hz" means that the mean service life (B50) has been determined with a 12h switching cycle at mains (frequency 50Hz), "3B50, HF" is based on a 3h switching cycle at electronic control gear (high frequency).

Base



E27
IEC/EN 60061-1
sheet 7004-21-9

Spectrum

Natural daylight is a mixture of direct sunlight and the light of the sky. Therefore, its spectral composition changes permanently due to the changing

Compact fluorescent lamp Ralux®Quick

RXP-Q 11W/827/E27

Radium

time of day. The standardised light classification D65 corresponds to a daylight with a colour temperature of approximately 6500 K. Every fluorescent lamp type has got an individual spectral power distribution according to its phosphor coating inside the bulb. From this result important properties light colour or colour rendering. Visible region from 380 to 780 nm; height of graph corresponding with relative spectral emission (400mW/klm) per 10nm.

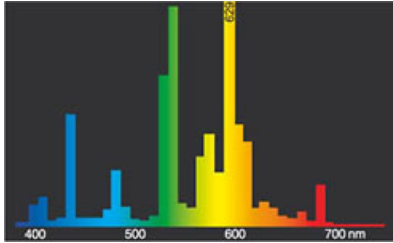

light colour 827 Spectralux® Intra (41)

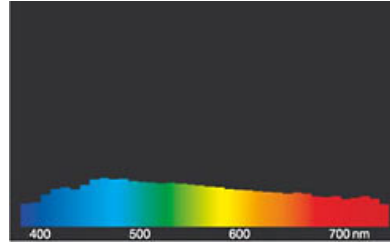

daylight(D 65)

Special features



General notes

The technical design data in accordance with DIN and IEC. The producer does not take any responsibility for damage to persons or property in case of unsuitable operation or handling of the product. Operating data and dimensions are valid within the usual tolerances. Related lamp types (different bases, mains voltages) may be available on request. Sale and delivery are effected in accordance with the Radium Terms of Delivery and Payment valid on the day of conclusion of contract. Packing units offer economical advantages to the purchase and logistic department. Please match your quantity volume accordingly. For orders of a minimum quantity (clefts) with a lamp model the amount lower than the volume of each packaging unit, we will invoice 10 % additional charge per lamp type. Technical changes and terms of delivery are reserved. Manipulation of any kind to packaging or product is not permissible as this will violate Radium brand rights. Furthermore, technical properties of the product can change to its disadvantage or even destruction. Therefore, Radium cannot be responsible for consequential damages.

® = Registered trademark

Subject to change without notice. Errors and omissions excepted.

All technical data without guarantee.