

Compact fluorescent lamp Ralux® Long

RX-L 80W/830/2G11 RO

Radium

Product Datasheet Date: 05.06.2026



A



G



6000



3000K



20 000h



Dimmable

General Data

Article No.	31313852
Codice	RX-L 80W/830/2G11 RO
Product EAN	4050300665467
Box quantity (pcs.)	10
EAN Box	4050300665474
Gross weight of box in kg	2.02
Length of box in m	0.14
Width of box in m	0.11
Height of box in m	0.62
Product weight	147 g
Product status	● Inattivo

Electric Parameters

Wattage	80.0 W
Lamp nominal wattage	80 W
Mains voltage	230 V
dimnable	Si

Light Application Parameters

Luminous flux	6500 lm
Rated lamp luminous flux	6000 lm
max. luminous flux at	25 °C
Efficacy / Luminous efficiency	75 lm/W
Light colour	warm white
Code of light color	830
Colour temperature	3000 K
Color rendering index	80-89
Mean luminance	3.7
Lumen maintenance at 2000h	0.94
Lumen maintenance at 4000h	0.90
Lumen maintenance at 6000h	0.88
Lumen maintenance at 8000h	0.85
Lumen maintenance at 12000h	0.84
Lumen maintenance at 16000h	0.81
Lumen maintenance at 20000h	0.80

Service Life

Average life	20000 h
No. switching cycles	>50000
Lamp survival factor at 2000h	0.99
Lamp survival factor at 4000h	0.99
Lamp survival factor at 6000h	0.99
Lamp survival factor at 8000h	0.99
Lamp survival factor at 12000h	0.95
Lamp survival factor at 16000h	0.81
Lamp survival factor at 20000h	0.50

Specification

Energylabel notice	old label, no EPREL registration, no EU data sheet
Energylabel (G -> A)	G
Energylabel (E -> A++)	A
Diameter	38 mm
Length	565 mm
Total length max.	565 mm
Mercury content	2.6 mg

Specification

Base	2G11
Colour	Other

Information especially for EPREL

Energylabel notice	old label, no EPREL registration, no EU data sheet
--------------------	--

Miscellaneous

EU-date of phase-out	25.02.2023
EU Directive	RoHS

Notes

Compact fluorescent lamp, light colour 830, high luminous efficiency, good colour rendering, long life, base 2G11. Controllable by Dim-ECG.

Please, refer to www.radium.de/recycling for notes on disposal of burned-out lamps as well as lamp breakage.

The "lifespan L70" described for LED lamps indicates the number of hours when the luminous flux has decreased to 70% of its initial value.

The optimal field 'info about service life' contains the frame conditions according to standards based on which the specific service life has been determined. So, for example, "12B50, 50Hz" means that the mean service life (B50) has been determined with a 12h switching cycle at mains (frequency 50Hz), "3B50, HF" is based on a 3h switching cycle at electronic control gear (high frequency).

Base

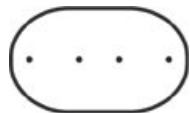

2G11
IEC/EN 60061-1
sheet 7004-82-1

Spectrum

Natural daylight is a mixture of direct sunlight and the light of the sky. Therefore, its spectral composition changes permanently due to the changing time of day. The standardised light classification D65 corresponds to a daylight with a colour temperature of approximately 6500 K.

Every fluorescent lamp type has got an individual spectral power distribution according to its phosphor coating inside the bulb. From this result important properties light colour or colour rendering.

Visible region from 380 to 780 nm; height of graph corresponding with relative spectral emission (400mW/klm) per 10nm.

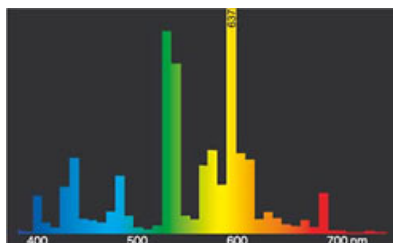

light colour 830 Spectralux® Warm white (31)

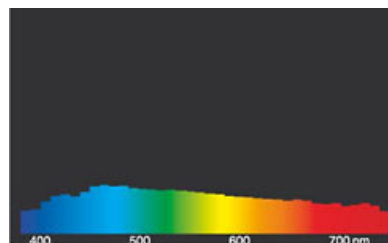

daylight(D 65)

Circuit diagram(s)

Compact fluorescent lamp Ralux® Long

RX-L 80W/830/2G11 RO

Radium

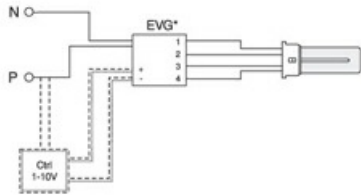

EinzelSchaltung mit EVG für Ralux®/E

Zeichenerklärung:

VG = Vorschaltgerät Elektronisch (EVG)

P = Phase

N = Null-Leiter

Ctrl = Steuer-/Regelgerät

Die notwendigen Geräte (hier elektronisches Vorschaltgerät) zum Betrieb der Lampe sind normalerweise bereits in den dafür geeigneten Leuchten in der entsprechenden Schaltung installiert. Änderungen aller Art sind daher nur von qualifiziertem Fachpersonal durchzuführen. Dieses Schaltungsbeispiel ist daher

lediglich als technische Hintergrund-Information für interessierte Anwender zu verstehen.



EinzelSchaltung mit VVG und Starter für Ralux®/E

Zeichenerklärung:

D = Drossel

St = Starter

VG = Vorschaltgerät Konventionell (KVG/VVG)

P = Phase

N = Null-Leiter

K = Kompensations-Kondensator

Die notwendigen Geräte (hier Starter und Vorschaltgerät) zum Betrieb der Lampe sind normalerweise bereits in den dafür geeigneten Leuchten in der entsprechenden Schaltung installiert. Änderungen aller Art sind daher nur von qualifiziertem Fachpersonal durchzuführen. Dieses Schaltungsbeispiel ist daher lediglich als technische Hintergrund-Information für interessierte Anwender zu verstehen.



EinzelSchaltung mit VVG und Starter für Ralux®/E

Zeichenerklärung:

D = Drossel

St = Starter

VG = Vorschaltgerät Konventionell (KVG/VVG)

P = Phase

N = Null-Leiter

K = Kompensations-Kondensator

Die notwendigen Geräte (hier Starter und Vorschaltgerät) zum Betrieb der Lampe sind normalerweise bereits in den dafür geeigneten Leuchten in der entsprechenden Schaltung installiert. Änderungen aller Art sind daher nur von qualifiziertem Fachpersonal durchzuführen. Dieses Schaltungsbeispiel ist daher lediglich als technische Hintergrund-Information für interessierte Anwender zu verstehen.



EinzelSchaltung mit VVG und Starter für Ralux®/E

Zeichenerklärung:

D = Drossel

St = Starter

VG = Vorschaltgerät Konventionell (KVG/VVG)

P = Phase

N = Null-Leiter

K = Kompensations-Kondensator

Die notwendigen Geräte (hier Starter und Vorschaltgerät) zum Betrieb der Lampe sind normalerweise bereits in den dafür geeigneten Leuchten in der entsprechenden Schaltung installiert. Änderungen aller Art sind daher nur von qualifiziertem Fachpersonal durchzuführen. Dieses Schaltungsbeispiel ist daher lediglich als technische Hintergrund-Information für interessierte Anwender zu verstehen.

Special features



General notes

The technical design data in accordance with DIN and IEC. The producer does not take any responsibility for damage to persons or property in case of unsuitable operation or handling of the product. Operating data and dimensions are valid within the usual tolerances. Related lamp types (different bases, mains voltages) may be available on request. Sale and delivery are effected in accordance with the Radium Terms of Delivery and Payment valid on the day of conclusion of contract. Packing units offer economical advantages to the purchase and logistic department. Please match your quantity volume accordingly. For orders of a minimum quantity (clefs) with a lamp model the amount lower than the volume of each packaging unit, we will invoice 10 % additional charge per lamp type. Technical changes and terms of delivery are reserved. Manipulation of any kind to packaging or

Compact fluorescent lamp Ralux® Long

RX-L 80W/830/2G11 RO

Radium

product is not permissible as this will violate Radium brand rights. Furthermore, technical properties of the product can change to its disadvantage or even destruction. Therefore, Radium cannot be responsible for consequential damages.

® = Registered trademark

Subject to change without notice. Errors and omissions excepted.

All technical data without guarantee.