

Compact fluorescent lamp Ralux®Twin

RX-TW 24W/827/2G10

Radium

Product Datasheet Date: 05.06.2026



A



1700



2700K



10 000h



Dimmable

General Data

Article No.	31311242
Codice	RX-TW 24W/827/2G10
Product EAN	4008597112423
Box quantity (pcs.)	10
EAN Box	4008597412424
Gross weight of box in kg	1.207
Length of box in m	0.28
Width of box in m	0.1
Height of box in m	0.19
Product weight	86 g
Product status	● Inattivo

Electric Parameters

Wattage	24.0 W
Lamp nominal wattage	24 W
Lamp voltage	87 V
Mains voltage	230 V
Compensation capacitor for 50Hz operation	3.6 μ F

Electric Parameters

dimmable	Si
----------	----

Light Application Parameters

Luminous flux	1700 lm
Rated lamp luminous flux	1700 lm
max. luminous flux at	25 °C
Efficacy / Luminous efficiency	70.83 lm/W
Light colour	Intra
Code of light color	827
Colour temperature	2700 K
Color rendering index	? 80
Mean luminance	2,5
Lumen maintenance at 2000h	0.90
Lumen maintenance at 4000h	0.86
Lumen maintenance at 6000h	0.83
Lumen maintenance at 8000h	0.81
Lumen maintenance at 12000h	0.77

Service Life

Average life	10000 h
Mean service life, HF 3h cycle	13000 h
Lamp survival factor at 2000h	0.99
Lamp survival factor at 4000h	0.99
Lamp survival factor at 6000h	0.95
Lamp survival factor at 8000h	0.88
Lamp survival factor at 12000h	0.64

Specification

Energylabel notice	old label, no EPREL registration, no EU data sheet
Energylabel (E -> A++)	A
Diameter	79 mm
Total length max.	170 mm
Length	165 mm
Mercury content	1.8 mg
Base	2G10
Colour	White

Information especially for EPREL

Energylabel notice

old label, no EPREL registration, no EU data sheet

Miscellaneous

EU-date of phase-out	25.02.2023
EU Directive	RoHS
Similar products	31313061

Notes

Compact fluorescent lamp, light colour 827, high luminous efficiency, good colour rendering, long life, base 2G10. Controllable by Dim-ECG.

Please, refer to www.radium.de/recycling for notes on disposal of burned-out lamps as well as lamp breakage.

The "lifespan L70" described for LED lamps indicates the number of hours when the luminous flux has decreased to 70% of its initial value.

The optimal field 'info about service life' contains the frame conditions according to standards based on which the specific service life has been determined. So, for example, "12B50, 50Hz" means that the mean service life (B50) has been determined with a 12h switching cycle at mains (frequency 50Hz), "3B50, HF" is based on a 3h switching cycle at electronic control gear (high frequency).

Base



2G10
IEC/EN 60061-1
sheet 7004-118-1

Spectrum

Natural daylight is a mixture of direct sunlight and the light of the sky. Therefore, its spectral composition changes permanently due to the changing time of day. The standardised light classification D65 corresponds to a daylight with a colour temperature of approximately 6500 K.

Every fluorescent lamp type has got an individual spectral power distribution according to its phosphor coating inside the bulb. From this result important properties light colour or colour rendering.

Visible region from 380 to 780 nm; height of graph corresponding with relative spectral emission (400mW/klm) per 10nm.

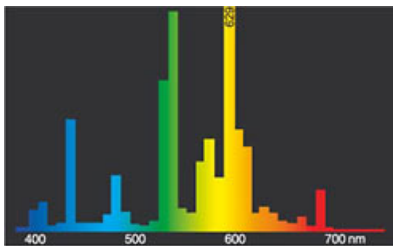

light colour 827 Spectralux® Intra (41)

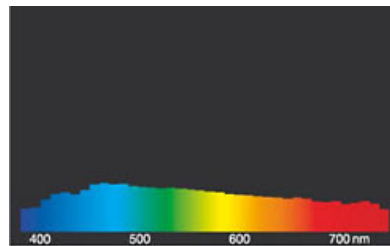

daylight(D 65)

Circuit diagram(s)



Einzelschaltung mit EVG für Ralux®/E

Zeichenerklärung:

VG = Vorschaltgerät Elektronisch (EVG)

P = Phase

N = Null-Leiter

Ctrl = Steuer-/Regelgerät

Die notwendigen Geräte (hier elektronisches Vorschaltgerät) zum Betrieb der Lampe sind normalerweise bereits in den dafür geeigneten Leuchten in der entsprechenden Schaltung installiert. Änderungen aller Art sind daher nur von qualifiziertem Fachpersonal durchzuführen. Dieses Schaltungsbeispiel ist daher lediglich als technische Hintergrund-Information für interessierte Anwender zu verstehen.

Compact fluorescent lamp Ralux®Twin

RX-TW 24W/827/2G10

Radium

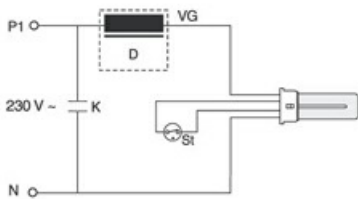

Einzelanschaltung mit VVG und Starter für Ralux®/E

Zeichenerklärung:

D = Drossel

St = Starter

VG = Vorschaltgerät Konventionell (KVG/VVG)

P = Phase

N = Null-Leiter

K = Kompensations-Kondensator

Die notwendigen Geräte (hier Starter und Vorschaltgerät) zum Betrieb der Lampe sind normalerweise bereits in den dafür geeigneten Leuchten in der entsprechenden Schaltung installiert. Änderungen aller Art sind daher nur von qualifiziertem Fachpersonal durchzuführen. Dieses Schaltungsbeispiel ist daher lediglich als technische Hintergrund-Information für interessierte Anwender zu verstehen.

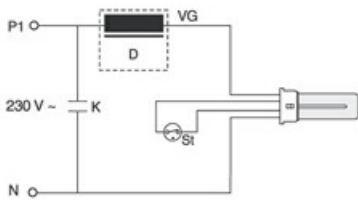

Einzelanschaltung mit VVG und Starter für Ralux®/E

Zeichenerklärung:

D = Drossel

St = Starter

VG = Vorschaltgerät Konventionell (KVG/VVG)

P = Phase

N = Null-Leiter

K = Kompensations-Kondensator

Die notwendigen Geräte (hier Starter und Vorschaltgerät) zum Betrieb der Lampe sind normalerweise bereits in den dafür geeigneten Leuchten in der entsprechenden Schaltung installiert. Änderungen aller Art sind daher nur von qualifiziertem Fachpersonal durchzuführen. Dieses Schaltungsbeispiel ist daher lediglich als technische Hintergrund-Information für interessierte Anwender zu verstehen.

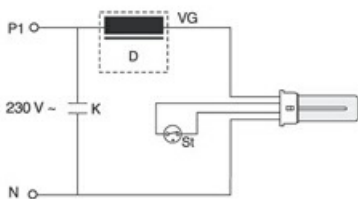

Einzelanschaltung mit VVG und Starter für Ralux®/E

Zeichenerklärung:

D = Drossel

St = Starter

VG = Vorschaltgerät Konventionell (KVG/VVG)

P = Phase

N = Null-Leiter

K = Kompensations-Kondensator

Die notwendigen Geräte (hier Starter und Vorschaltgerät) zum Betrieb der Lampe sind normalerweise bereits in den dafür geeigneten Leuchten in der entsprechenden Schaltung installiert. Änderungen aller Art sind daher nur von qualifiziertem Fachpersonal durchzuführen. Dieses Schaltungsbeispiel ist daher lediglich als technische Hintergrund-Information für interessierte Anwender zu verstehen.

Special features



General notes

The technical design data in accordance with DIN and IEC. The producer does not take any responsibility for damage to persons or property in case of unsuitable operation or handling of the product. Operating data and dimensions are valid within the usual tolerances. Related lamp types (different bases, mains voltages) may be available on request. Sale and delivery are effected in accordance with the Radium Terms of Delivery and Payment valid on the day of conclusion of contract. Packing units offer economical advantages to the purchase and logistic department. Please match your quantity volume accordingly. For orders of a minimum quantity (clefts) with a lamp model the amount lower than the volume of each packaging unit, we will invoice 10 % additional charge per lamp type. Technical changes and terms of delivery are reserved. Manipulation of any kind to packaging or product is not permissible as this will violate Radium brand rights. Furthermore, technical properties of the product can change to its disadvantage or even destruction. Therefore, Radium cannot be responsible for consequential damages.

® = Registered trademark

Subject to change without notice. Errors and omissions excepted.

All technical data without guarantee.