

Fluorescent lamp Spectralux®

NL-T5 8W/840/G5

Radium

Product Datasheet Date: 09.06.2026

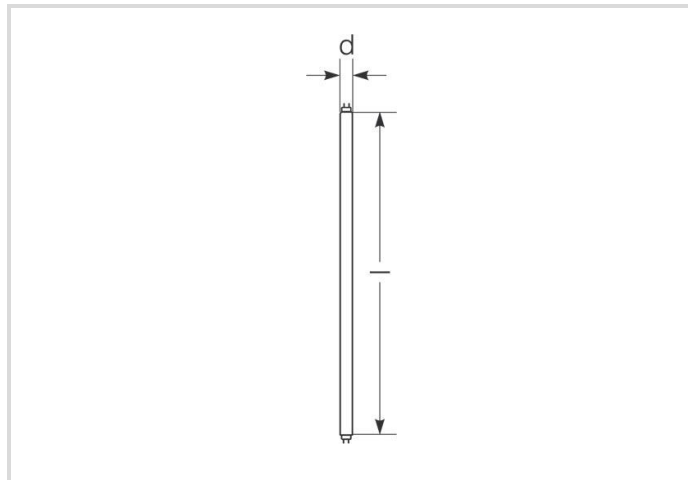

A



G



430



4000K



10 000h



Dimmable

General Data

Article No.	31118352
Codice	NL-T5 8W/840/G5
Product EAN	4008597183522
Box quantity (pcs.)	25
EAN Box	4008597483523
Gross weight of box in kg	1.001
Length of box in m	0.311
Width of box in m	0.1
Height of box in m	0.113
Product weight	29 g
Product status	● Inattivo

Electric Parameters

Wattage	8.0 W
Lamp nominal wattage	8 W
Lamp voltage	56 V
Mains voltage	230 V
Nominal current (mA)	145 mA

Electric Parameters

Compensation capacitor for 50Hz operation	2 µF
dimnable	Si
Controllable (in suitable circuit)	Si

Light Application Parameters

Luminous flux	430 lm
Rated lamp luminous flux	430 lm
max. luminous flux at	25 °C
Efficacy / Luminous efficiency	53.75 lm/W
Total mains efficacy	56 lm/W
Light colour	white
Code of light color	840
Colour temperature	4000 K
Color rendering index	? 80
Mean luminance	0.9
Lumen maintenance at 2000h	0.90
Lumen maintenance at 4000h	0.84
Lumen maintenance at 6000h	0.79
Lumen maintenance at 8000h	0.75

Service Life

Average life	10000 h
Lamp survival factor at 2000h	0.99
Lamp survival factor at 4000h	0.99
Lamp survival factor at 6000h	0.95
Lamp survival factor at 8000h	0.81

Specification

Energylabel notice	old label, no EPREL registration, no EU data sheet
Energylabel (G -> A)	G
Energylabel (E -> A++)	A
Diameter max.	16 mm
Tube diameter	16 mm
Length	288 mm
Length	288 mm
Mercury content	2.6 mg

Specification

Lamp shape	Rod
Base	G5
Colour	Other

Information especially for EPREL

Energylabel notice	old label, no EPREL registration, no EU data sheet
EPREL ID number	907120

Miscellaneous

EU-date of phase-out	25.08.2023
EU Directive	RoHS

Notes

Fluorescent lamp T5 - 16mm diameter, light colour 840, high luminous efficiency, good colour rendering, long life, base G5. Controllable by Dim-ECG.

Please, refer to www.radium.de/recycling for notes on disposal of burned-out lamps as well as lamp breakage.

The "lifespan L70" described for LED lamps indicates the number of hours when the luminous flux has decreased to 70% of its initial value.

The optimal field 'info about service life' contains the frame conditions according to standards based on which the specific service life has been determined. So, for example, "12B50, 50Hz" means that the mean service life (B50) has been determined with a 12h switching cycle at mains (frequency 50Hz), "3B50, HF" is based on a 3h switching cycle at electronic control gear (high frequency).

Base



G5
IEC/EN 60061-1
sheet 7004-52-5

Spectrum

Natural daylight is a mixture of direct sunlight and the light of the sky. Therefore, its spectral composition changes permanently due to the changing time of day. The standardised light classification D65 corresponds to a daylight with a colour temperature of approximately 6500 K.

Every fluorescent lamp type has got an individual spectral power distribution according to its phosphor coating inside the bulb. From this result important properties light colour or colour rendering.

Visible region from 380 to 780 nm; height of graph corresponding with relative spectral emission (400mW/klm) per 10nm.

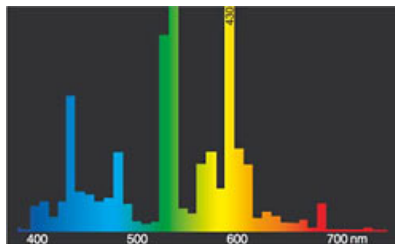

light colour 840 Spectralux® white (21)

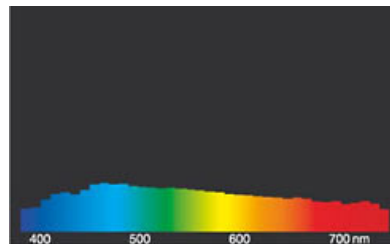

daylight(D 65)

Circuit diagram(s)

Fluorescent lamp Spectralux®

NL-T5 8W/840/G5

Radium

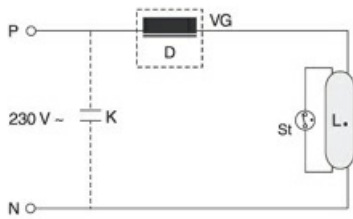

One-lampe circuit inductive

Key:

D = choke

L. = lamp

St = starter

VG = electromagnetic ballast (KVG/VVG)

P = phase

N = zero potential

K = p. f. correction capacitor

The required control gear (here starter and ballast) for the lamps operation is usually mounted in the suitable luminaire in an appropriate electric circuit. Changes of any kind are to be conducted by qualified and specialised staff, only. Thus, this circuit example is to be understood merely as a technical background information for interested users.

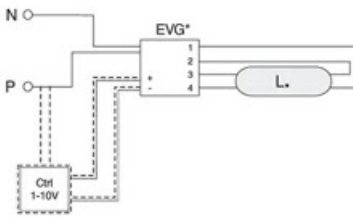

One-lampe circuit with electronic ballast

Key:

VG = ballast electronic (ECG)

P = phase

N = zero potential

Ctrl = Controller, dimmer

The required control gear (here electronic ballast) for the lamps operation is usually mounted in the suitable luminaire in an appropriate electric circuit. Changes of any kind are to be conducted by qualified and specialised staff, only. Thus, this circuit example is to be understood merely as a technical background information for interested users.

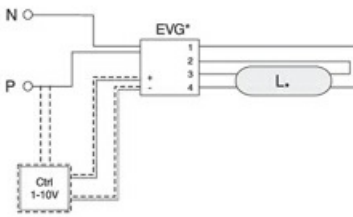

One-lampe circuit with electronic ballast

Key:

VG = ballast electronic (ECG)

P = phase

N = zero potential

Ctrl = Controller, dimmer

The required control gear (here electronic ballast) for the lamps operation is usually mounted in the suitable luminaire in an appropriate electric circuit. Changes of any kind are to be conducted by qualified and specialised staff, only. Thus, this circuit example is to be understood merely as a technical background information for interested users.

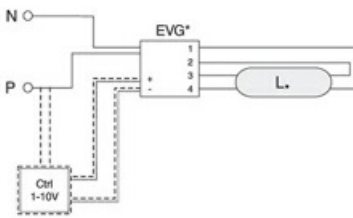

One-lampe circuit with electronic ballast

Key:

VG = ballast electronic (ECG)

P = phase

N = zero potential

Ctrl = Controller, dimmer

The required control gear (here electronic ballast) for the lamps operation is usually mounted in the suitable luminaire in an appropriate electric circuit. Changes of any kind are to be conducted by qualified and specialised staff, only. Thus, this circuit example is to be understood merely as a technical background information for interested users.

Special features



General notes

The technical design data in accordance with DIN and IEC. The producer does not take any responsibility for damage to persons or property in case of unsuitable operation or handling of the product. Operating data and dimensions are valid within the usual tolerances. Related lamp types (different bases, mains voltages) may be available on request. Sale and delivery are effected in accordance with the Radium Terms of Delivery and Payment valid on the day of conclusion of contract. Packing units offer economical advantages to the purchase and logistic department. Please match your quantity volume accordingly. For orders of a minimum quantity (clefts) with a lamp model the amount lower than the volume of each packaging unit, we will invoice 10 % additional charge per lamp type. Technical changes and terms of delivery are reserved. Manipulation of any kind to packaging or product is not permissible as this will violate Radium brand rights. Furthermore, technical properties of the product can change to its disadvantage or even destruction. Therefore, Radium cannot be responsible for consequential damages.

® = Registered trademark

Subject to change without notice. Errors and omissions excepted.

Fluorescent lamp Spectralux®

NL-T5 8W/840/G5

Radium

All technical data without guarantee.