

LED Surface Luminaire Essence IP54

Surface E 250 12W CCT

Radium

Product Datasheet Date: 02.04.2026

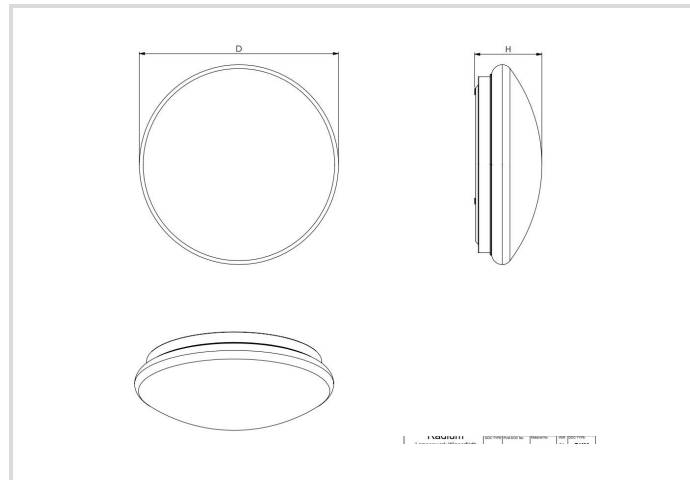

30004000K

General Data

Code Radium	SFEA5097
Désignation	SF E 250 12W CCT IP54
EAN 10 (unité)	4003556015159
Unité de transport (pièces)	6
EAN 40 (carton)	4003556415157
Poids brut du carton en kg	3.09
Longueur box in m	0.548
Largeur du carton en m	0.275
Hauteur du carton en m	0.28
Product weight	310 g
Product status	● Actif

Electric Parameters

Max. system power	12.0 W
Nominal voltage	220-240 V
Voltage type	AC
Nominal current	90 mA
Nominal current (mA)	90 mA

Electric Parameters

Inrush current	1 A
Mains frequency	50/60 Hz Hz
Dimming with push-button	Non

Light Application Parameters

Luminous flux adjustable	Non
Luminous flux	1025 lm
Rated luminous flux according to IEC 62722-2-1	1025 lm
Luminous flux @3000K	950 lm
Luminous flux @4000K	1025 lm
Beam angle adjustable	Non
Beam angle	120 °
Unified Glare Ratio (UGR)	28
Efficacy	85 lm/W
Total mains efficacy	85 lm/W
Colour of light adjustable	Positions
CCT Switch	Non
Colour of light	White
Color temperature	3000 / 4000 K
Color coordinate X	0.434
Color coordinate Y	0.403
Color rendering index	≥ 80
Color Stability	≤ 6 sdcn
With light sensor	Non

Service Life

Lifetime L70B50	30000 h
Life L80B10	30000 h
No. switching cycles	≥ 50.000
Guarantee	3

Specification

Diameter	250 mm
Length	250 mm
Height/depth	80 mm
Width	250 mm

LED Surface Luminaire Essence IP54

Surface E 250 12W CCT

Radium

Specification

Material	CC1000069
Impact strength	IK03
Photobiological safety according to EN 62471	RG0
With light source	Oui
Exchangeable control gear	Oui

Notes on Operation

Degree of protection (IP)	IP54
Connection type	Push-in clamp
Type of wiring	Ending
Max. number of luminaires per B10 circuit breaker	82
Max. number of luminaires per B16 circuit breaker	130
Filament test according to IEC 60695-2-11	650 °C - 30 s
Type of control gear	LED operating device voltage-controlled
With light sensor	Non
With movement sensor	Non
Suitable for emergency lighting	Non
Emergency power supply integrated	Non

Information especially for EPREL

Mains/Non mains connectable	MLS
Directional or non-directional light	NDLS
Color tunable light source	Oui
Type of color temperature	STEPS
Flickering value Pst LM	1
Stroboscope effect value SVM	0.4

Notes

Universal LED wall and ceiling luminaire IP54, integrated LED driver with power select, adjustable light color (steps)

Please, refer to www.radium.de/recycling for notes on disposal of burned-out lamps as well as lamp breakage.

The "lifespan L70" described for LED lamps indicates the number of hours when the luminous flux has decreased to 70% of its initial value.

The optimal field 'info about service life' contains the frame conditions according to standards based on which the specific service life has been determined. So, for example, "12B50, 50Hz" means that the mean service life (B50) has been determined with a 12h switching cycle at mains (frequency 50Hz), "3B50, HF" is based on a 3h switching cycle at electronic control gear (high frequency).

Particularités



Notices explicatives générales

LED Surface Luminaire Essence IP54

Surface E 250 12W CCT

Radium

The technical design data in accordance with DIN and IEC. The producer does not take any responsibility for damage to persons or property in case of unsuitable operation or handling of the product. Operating data and dimensions are valid within the usual tolerances. Related lamp types (different bases, mains voltages) may be available on request. Sale and delivery are effected in accordance with the Radium Terms of Delivery and Payment valid on the day of conclusion of contract. Packing units offer economical advantages to the purchase and logistic department. Please match your quantity volume accordingly. For orders of a minimum quantity (clefts) with a lamp model the amount lower than the volume of each packaging unit, we will invoice 10 % additional charge per lamp type. Technical changes and terms of delivery are reserved. Manipulation of any kind to packaging or product is not permissible as this will violate Radium brand rights. Furthermore, technical properties of the product can change to its disadvantage or even destruction. Therefore, Radium cannot be responsible for consequential damages.

® = Registered trademark

Subject to change without notice. Errors and omissions excepted.

All technical data without guarantee.