

Compact fluorescent lamp Ralux®Twin

RX-TW 36W/830/2G10

Radium

Product Datasheet Date: 02.04.2026



G



2800



3000K



10 000h



Gradable

General Data

Code Radium	31313056
Désignation	RX-TW 36W/830/2G10
EAN 10 (unité)	4008597130564
Unité de transport (pièces)	10
EAN 40 (carton)	4008597430565
Poids brut du carton en kg	1.382
Longueur box in m	0.28
Largeur du carton en m	0.1
Hauteur du carton en m	0.245
Product weight	100 g
Product status	● Inactif

Electric Parameters

Wattage	36.0 W
Lamp nominal wattage	36 W
Weighted energy consumption in 1000 hours	38 kWh
Lamp voltage	106 V
Mains voltage	230 V

Electric Parameters

Compensation capacitor for 50Hz operation	4.4 µF
dimnable	Oui

Light Application Parameters

Luminous flux	2800 lm
Rated lamp luminous flux	2800 lm
max. luminous flux at	25 °C
Efficacy	78 lm/W
Light colour	warm white
Code of light color	830
Colour temperature	3000 K
Color coordinate X	0.440
Color coordinate Y	0,403
Color rendering index	? 80
Mean luminance	3
Lumen maintenance at 2000h	0.90
Lumen maintenance at 4000h	0.86
Lumen maintenance at 6000h	0.83
Lumen maintenance at 8000h	0.81
Lumen maintenance at 12000h	0.77

Service Life

Average life	10000 h
Mean service life, HF 3h cycle	13000 h
Lamp survival factor at 2000h	0.99
Lamp survival factor at 4000h	0.99
Lamp survival factor at 6000h	0.99
Lamp survival factor at 8000h	0.95
Lamp survival factor at 12000h	0.64

Specification

Energylabel notice	current label, with EPREL registration
Energylabel (G -> A)	G
Diameter	79 mm
Total length max.	221 mm
Length	217 mm

Specification

Mercury content	1.8 mg
Base	2G10
Colour	White

Notes on Operation

Ambient temperatures	-5 ... +40 °C
----------------------	---------------

Information especially for EPREL

Energylabel notice	current label, with EPREL registration
EPREL ID number	541214

Miscellaneous

EU-date of phase-out	25.02.2023
EU Directive	RoHS
Similar products	31313055, 43619784

Notes

Compact fluorescent lamp, light colour 830, high luminous efficiency, good colour rendering, long life, base 2G10. Controllable by Dim-ECG.

Please, refer to www.radium.de/recycling for notes on disposal of burned-out lamps as well as lamp breakage.

The "lifespan L70" described for LED lamps indicates the number of hours when the luminous flux has decreased to 70% of its initial value.

The optimal field 'info about service life' contains the frame conditions according to standards based on which the specific service life has been determined. So, for example, "12B50, 50Hz" means that the mean service life (B50) has been determined with a 12h switching cycle at mains (frequency 50Hz), "3B50, HF" is based on a 3h switching cycle at electronic control gear (high frequency).

Culot



2G10
IEC/EN 60061-1
sheet 7004-118-1

Courbes spectrales

Natural daylight is a mixture of direct sunlight and the light of the sky. Therefore, its spectral composition changes permanently due to the changing time of day. The standardised light classification D65 corresponds to a daylight with a colour temperature of approximately 6500 K.

Every fluorescent lamp type has got an individual spectral power distribution according to its phosphor coating inside the bulb. From this result important properties light colour or colour rendering.

Visible region from 380 to 780 nm; height of graph corresponding with relative spectral emission (400mW/klm) per 10nm.

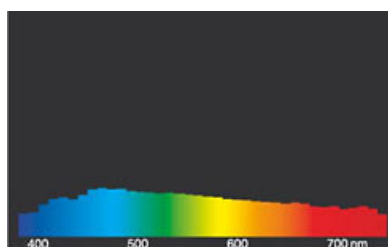
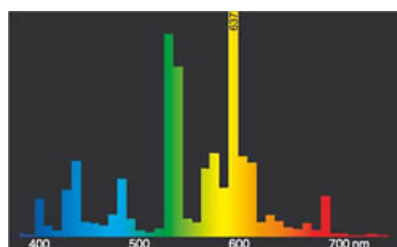

Compact fluorescent lamp Ralux®Twin

RX-TW 36W/830/2G10

Radium

light colour 830 Spectralux® Warm white (31)

daylight(D 65)

Exemple(s) de circuit



Einzelschaltung mit EVG für Ralux®/E

Zeichenerklärung:

VG = Vorschaltgerät Elektronisch (EVG)

P = Phase

N = Null-Leiter

Ctrl = Steuer-/Regelgerät

Die notwendigen Geräte (hier elektronisches Vorschaltgerät) zum Betrieb der Lampe sind normalerweise bereits in den dafür geeigneten Leuchten in der entsprechenden Schaltung installiert. Änderungen aller Art sind daher nur von qualifiziertem Fachpersonal durchzuführen. Dieses Schaltungsbeispiel ist daher

lediglich als technische Hintergrund-Information für interessierte Anwender zu verstehen.

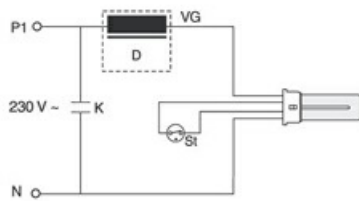

Einzelschaltung mit VVG und Starter für Ralux®/E

Zeichenerklärung:

D = Drossel

St = Starter

VG = Vorschaltgerät Konventionell (KVG/VVG)

P = Phase

N = Null-Leiter

K = Kompensations-Kondensator

Die notwendigen Geräte (hier Starter und Vorschaltgerät) zum Betrieb der Lampe sind normalerweise bereits in den dafür geeigneten Leuchten in der entsprechenden Schaltung installiert. Änderungen aller Art sind daher nur von qualifiziertem Fachpersonal durchzuführen. Dieses Schaltungsbeispiel ist daher lediglich als technische Hintergrund-Information für interessierte Anwender zu verstehen.

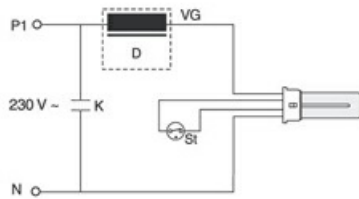

Einzelschaltung mit VVG und Starter für Ralux®/E

Zeichenerklärung:

D = Drossel

St = Starter

VG = Vorschaltgerät Konventionell (KVG/VVG)

P = Phase

N = Null-Leiter

K = Kompensations-Kondensator

Die notwendigen Geräte (hier Starter und Vorschaltgerät) zum Betrieb der Lampe sind normalerweise bereits in den dafür geeigneten Leuchten in der entsprechenden Schaltung installiert. Änderungen aller Art sind daher nur von qualifiziertem Fachpersonal durchzuführen. Dieses Schaltungsbeispiel ist daher lediglich als technische Hintergrund-Information für interessierte Anwender zu verstehen.

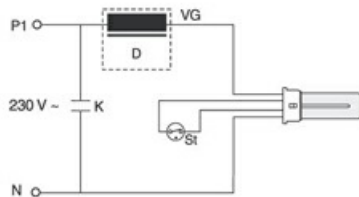

Einzelschaltung mit VVG und Starter für Ralux®/E

Zeichenerklärung:

D = Drossel

St = Starter

VG = Vorschaltgerät Konventionell (KVG/VVG)

P = Phase

N = Null-Leiter

K = Kompensations-Kondensator

Die notwendigen Geräte (hier Starter und Vorschaltgerät) zum Betrieb der Lampe sind normalerweise bereits in den dafür geeigneten Leuchten in der entsprechenden Schaltung installiert. Änderungen aller Art sind daher nur von qualifiziertem Fachpersonal durchzuführen. Dieses Schaltungsbeispiel ist daher lediglich als technische Hintergrund-Information für interessierte Anwender zu verstehen.

Particularités



Notices explicatives générales

The technical design data in accordance with DIN and IEC. The producer does not take any responsibility for damage to persons or property in case of unsuitable operation or handling of the product. Operating data and dimensions are valid within the usual tolerances. Related lamp types (different bases, mains voltages) may be available on request. Sale and delivery are effected in accordance with the Radium Terms of Delivery and Payment

Compact fluorescent lamp Ralux®Twin

RX-TW 36W/830/2G10

Radium

valid on the day of conclusion of contract. Packing units offer economical advantages to the purchase and logistic department. Please match your quantity volume accordingly. For orders of a minimum quantity (clefts) with a lamp model the amount lower than the volume of each packaging unit, we will invoice 10 % additional charge per lamp type. Technical changes and terms of delivery are reserved. Manipulation of any kind to packaging or product is not permissible as this will violate Radium brand rights. Furthermore, technical properties of the product can change to its disadvantage or even destruction. Therefore, Radium cannot be responsible for consequential damages.

® = Registered trademark

Subject to change without notice. Errors and omissions excepted.

All technical data without guarantee.