

# LED Star PAR16

RL PAR16 50 DIM 5,5W/230/WFL/830/GU10

# Radium

Product Datasheet Date: 02.04.2026

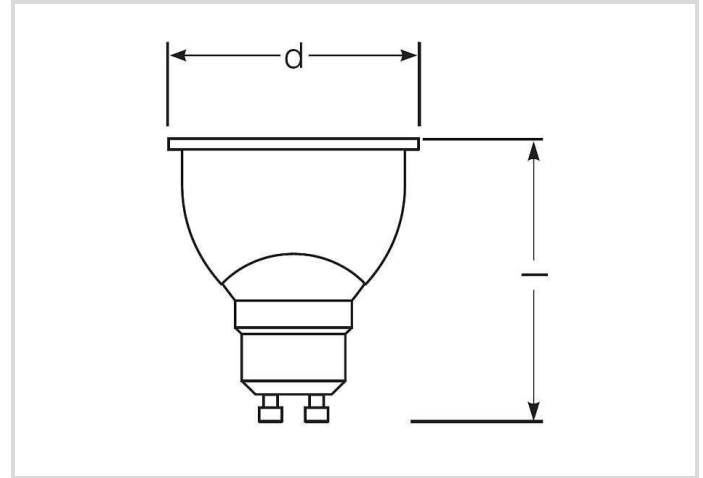

A+



350



3000K



25 000h



## General Data

Code Radium	42919038
Désignation	RL PAR16 50 DIM WFL/830
EAN 10 (unité)	4008597190384
Unité de transport (pièces)	10
EAN 40 (carton)	4008597490385
Poids brut du carton en kg	0.862
Longueur box in m	0.27
Largeur du carton en m	0.11
Hauteur du carton en m	0.08
Product weight	72 g
Product status	<span style="color: red;">●</span> Inactif

## Electric Parameters

Wattage	5.5 W
Power factor	0.9
Nominal voltage	220-240 V
Mains Voltage	220 - 240 V
Voltage type	AC

# LED Star PAR16

RL PAR16 50 DIM 5,5W/230/WFL/830/GU10

# Radium

## Electric Parameters

Nominal current (mA)	25 mA
----------------------	-------

## Light Application Parameters

Rated lamp luminous flux	350 lm
Luminous flux in 90°-sector	350 lm
Luminous intensity	850 cd
Beam angle	36 °
Efficacy	63.64 lm/W
Color temperature	3000 K
Color rendering index	≥ 80
Color Stability	≤ 5 sdcn

## Service Life

Average life	25000 h
Mean service life	25000 h
No. switching cycles	100000
Lamp survival factor at 6000h	≥ 0.90
Early failure rate at 1000h	≤ 5.0 %
Guarantee	5 years

## Specification

Energylabel notice	old label, no EPREL registration, no EU data sheet
Energylabel (E -> A++)	A+
Diameter	50 mm
Length	58 mm
Length	58 mm
Burning position	any
Mercury content	0.0 mg
Photobiological safety according to EN 62471	RG1
Lamp shape	Reflector
Base	GU10
Colour	White

## Notes on Operation

Degree of protection (IP)	IP20
Burning position	any
Mode of operation	230 V

# LED Star PAR16

RL PAR16 50 DIM 5,5W/230/WFL/830/GU10

# Radium

## Notes on Operation

Ambient temperatures	-20...+40 °C
With movement sensor	Non

## Information especially for EPREL

Energylabel notice	old label, no EPREL registration, no EU data sheet
Lighting technology	LED
Mains/Non mains connectable	MLS
Directional or non-directional light	DLS
Color tunable light source	Non
Type of color temperature	SINGLE_VALUE
Flicker	1.0
Stroboscopic effect	0.4

## Notes

PAR16-LED for exchange with halogen lamps, warm white light, plastic body, dimmable, base GU10. LED light does not contain UV or IR radiation.

Please, refer to [www.radium.de/recycling](http://www.radium.de/recycling) for notes on disposal of burned-out lamps as well as lamp breakage.

The "lifespan L70" described for LED lamps indicates the number of hours when the luminous flux has decreased to 70% of its initial value.

The optimal field 'info about service life' contains the frame conditions according to standards based on which the specific service life has been determined. So, for example, "12B50, 50Hz" means that the mean service life (B50) has been determined with a 12h switching cycle at mains (frequency 50Hz), "3B50, HF" is based on a 3h switching cycle at electronic control gear (high frequency).

### Culot



GU10  
IEC/EN 60061-1  
sheet 7004-121-1

### Courbes spectrales

As daylight is a mixture of direct sunlight and light from the sky, the spectral distribution changes all the time due to the time of the day and the weather. The standard illuminant D65 corresponds to daylight with colour temperature of about 6500K.

The colour of coloured LEDs depends on the chemical elements within the light generating chip. The coloured light is generated directly and does not need filtering.

White LEDs are either RGB (red + green + blue chip in one LED = light colour white) or blue LED-chips with yellow/orange phosphor in the resin.

Visible region from 380 to 780 nm; height of graph corresponding with relative spectral emission (400mW/klm)per 10nm.

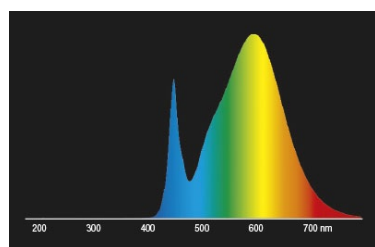

LED Retrofit retrofit lamps 3000K

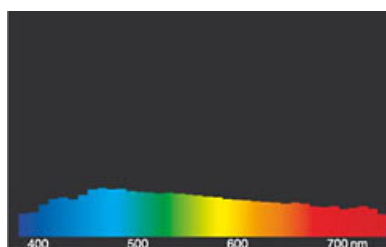

daylight(D 65)

### Particularités

# LED Star PAR16

RL PAR16 50 DIM 5,5W/230/WFL/830/GU10

# Radium

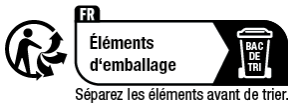

## Notices explicatives générales

For LED replacement of halogen and incandescent lamps, we recommend direct replacement (1: 1) at the respective burning position. For new systems, the number of lamps in the circuit operated at control gear such as transformers or dimmers can be obtained from corresponding compatibility lists (if available). If there is no specification for the type of device or lamp required, for safety reasons, the replacement power shall be assumed as that of the original halogen type (eg "RL-MR16 35" -> 35W, independent of the real power consumption).

The technical design data in accordance with DIN and IEC. The producer does not take any responsibility for damage to persons or property in case of unsuitable operation or handling of the product. Operating data and dimensions are valid within the usual tolerances. Related lamp types (different bases, mains voltages) may be available on request. Sale and delivery are effected in accordance with the Radium Terms of Delivery and Payment valid on the day of conclusion of contract. Packing units offer economical advantages to the purchase and logistic department. Please match your quantity volume accordingly. For orders of a minimum quantity (clefts) with a lamp model the amount lower than the volume of each packaging unit, we will invoice 10 % additional charge per lamp type. Technical changes and terms of delivery are reserved. Manipulation of any kind to packaging or product is not permissible as this will violate Radium brand rights. Furthermore, technical properties of the product can change to its disadvantage or even destruction. Therefore, Radium cannot be responsible for consequential damages.

® = Registered trademark

Subject to change without notice. Errors and omissions excepted.

## Consignes de sécurité

To ensure full light efficiency and product life, the permissible temperature ranges must be observed and dry environment ensured. When operated with existing control gear, their compatibility with the lamp must be checked.

All technical data without guarantee.