

# LED Downlight Essence IP54

95-105mm 7.5W/840 IP54

# Radium

Product Datasheet Date: 23.04.2026

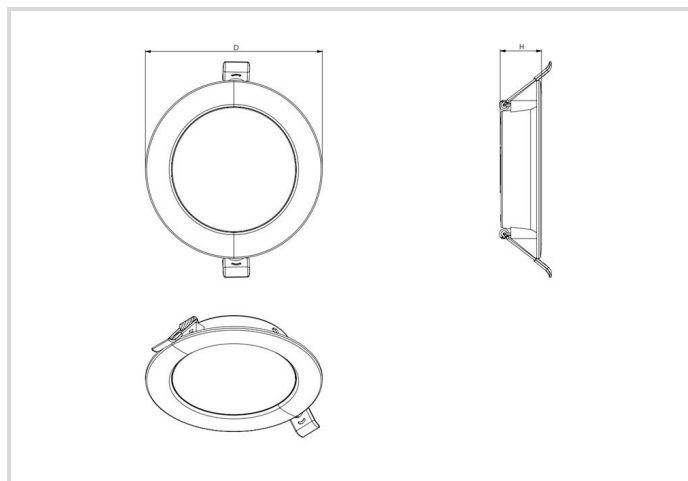

4000K



3  
YEARS  
GUARANTEE

## General Data

Article No.	DLEA5105
Code	DL E 95-105 7.5W/840 IP54
Product EAN	4003556015357
Box quantity (pcs.)	24
EAN Box	4003556415355
Gross weight of box in kg	2.292
Length of box in m	0.252
Width of box in m	0.244
Height of box in m	0.261
Product weight	60 g
Product status	<span style="color: green;">●</span> Active

## Electric Parameters

Max. system power	7.5 W
Nominal voltage	220-240 V
Voltage type	AC
Nominal current	58 mA
Nominal current (mA)	58 mA

# LED Downlight Essence IP54

95-105mm 7.5W/840 IP54

# Radium

## Electric Parameters

Number of poles	2
Inrush current	1 A
Mains frequency	50/60 Hz Hz
Dimming with push-button	No
Power Select	No

## Light Application Parameters

Luminous flux adjustable	No
Luminous flux	825 lm
Luminous flux	825 lm
Beam angle adjustable	No
Beam angle	110 °
Unified Glare Ratio (UGR)	28
Efficacy	100 lm/W
Total mains efficacy	100 lm/W
Colour of light adjustable	No
CCT Switch	No
Colour of light	White
Color temperature	4000 K
Color coordinate X	0.382
Color coordinate Y	0.398
Color rendering index	≥ 80
Color Stability	≤ 6 sdcn
Light sharing	Symmetric
With light sensor	No

## Service Life

Lifetime L70B50	30000 h
Life L80B10	30000 h
No. switching cycles	≥ 50 000
Guarantee	3

## Specification

Diameter	116 mm
Length	116 mm
Height/depth	25 mm

# LED Downlight Essence IP54

95-105mm 7.5W/840 IP54

# Radium

## Specification

Width	116 mm
Cable Length	0.1 m
Material	PC/ PS
Impact strength	IK03
Photobiological safety according to EN 62471	RG0
With light source	Yes
Exchangeable control gear	No

## Notes on Operation

Degree of protection (IP)	IP54
Connection type	Other
Type of wiring	Ending
Max. number of luminaires per B10 circuit breaker	131
Max. number of luminaires per B16 circuit breaker	209
Ambient temperatures	-20...+40 °C
Luminaire with limited surface temperature, sign "D" according to EN 60598-2-24	No
Filament test according to IEC 60695-2-11	650 °C - 30 s
Type of control gear	LED operating device voltage-controlled
With light sensor	No
With movement sensor	No
Emergency power supply integrated	No

## Information especially for EPREL

Lighting technology	LED
Mains/Non mains connectable	MLS
Directional or non-directional light	DLS
Color tunable light source	No
Type of color temperature	SINGLE_VALUE
Flicker	1.0
Stroboscopic effect	0.4
EPREL ID number	2676658

## Notes

Flat LED downlight IP54 for surface/recessed mounting and various ceiling cutouts, Power Select, uniform light emission.

Please, refer to [www.radium.de/recycling](http://www.radium.de/recycling) for notes on disposal of burned-out lamps as well as lamp breakage.

The "lifespan L70" described for LED lamps indicates the number of hours when the luminous flux has decreased to 70% of its initial value.

The optimal field 'info about service life' contains the frame conditions according to standards based on which the specific service life has been determined. So, for example, "12B50, 50Hz" means that the mean service life (B50) has been determined with a 12h switching cycle at mains (frequency 50Hz), "3B50, HF" is based on a 3h switching cycle at electronic control gear (high frequency).

# LED Downlight Essence IP54

95-105mm 7.5W/840 IP54

# Radium

## Special features



## General notes

The technical design data in accordance with DIN and IEC. The producer does not take any responsibility for damage to persons or property in case of unsuitable operation or handling of the product. Operating data and dimensions are valid within the usual tolerances. Related lamp types (different bases, mains voltages) may be available on request. Sale and delivery are effected in accordance with the Radium Terms of Delivery and Payment valid on the day of conclusion of contract. Packing units offer economical advantages to the purchase and logistic department. Please match your quantity volume accordingly. For orders of a minimum quantity (clefts) with a lamp model the amount lower than the volume of each packaging unit, we will invoice 10 % additional charge per lamp type. Technical changes and terms of delivery are reserved. Manipulation of any kind to packaging or product is not permissible as this will violate Radium brand rights. Furthermore, technical properties of the product can change to its disadvantage or even destruction. Therefore, Radium cannot be responsible for consequential damages.

® = Registered trademark

Subject to change without notice. Errors and omissions excepted.

All technical data without guarantee.