

LED Downlight Star Multi IP54

50-180 18W PS CCT

Radium

Product Datasheet Date: 23.04.2026

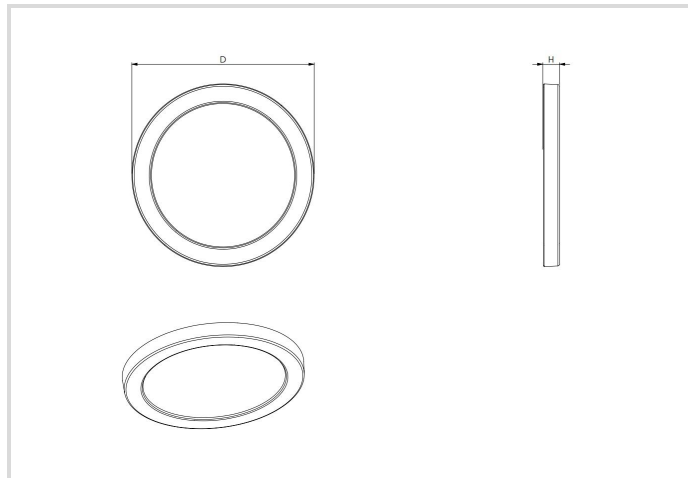

30006000K

General Data

Article No.	DLMA5129
Code	DL S M 50-180 18W PS CCT
Product EAN	4003556015562
Box quantity (pcs.)	10
EAN Box	4003556415560
Gross weight of box in kg	6.7
Length of box in m	0.345
Width of box in m	0.245
Height of box in m	0.25
Product weight	180 g
Product status	● Active

Electric Parameters

Max. system power	18.0 W
Nominal voltage	220-240 V
Voltage type	AC
Nominal current	150 mA
Number of poles	2

Electric Parameters

Mains frequency	50/60 Hz Hz
Dimming with push-button	No
Power Select	Yes

Light Application Parameters

Luminous flux adjustable	Positions
Luminous flux	2160 lm
Luminous flux	1080-2160 lm
Luminous flux @4000K	1080-2160 lm
Beam angle adjustable	No
Efficacy	135 lm/W
Total mains efficacy	135 lm/W
Colour of light adjustable	Positions
CCT Switch	Yes
Colour of light	White
Color temperature	3000 / 4000 / 6000 K
Color rendering index	≥ 80
Color Stability	≤ 6 sdcn
Light sharing	Symmetric
With light sensor	Yes

Service Life

Rated life time L70/B50 at 25 °C	100000 h
No. switching cycles	≥ 50 000
Guarantee	5

Specification

Diameter	225 mm
Length	225 mm
Height/depth	19 mm
Material	PC/ PS
Impact strength	IK05
Photobiological safety according to EN 62471	RG0
With light source	Yes
Exchangeable control gear	Yes

Notes on Operation

Degree of protection (IP)	IP20
Connection type	Push-in clamp
Type of wiring	Suitable for through wiring
Ambient temperatures	-20...+40 °C
Luminaire with limited surface temperature, sign "D" according to EN 60598-2-24	No
Filament test according to IEC 60695-2-11	650 °C - 30 s
Type of control gear	LED operating device voltage-controlled
With light sensor	Yes
With movement sensor	Yes
Emergency power supply integrated	No

Information especially for EPREL

Contains a lightsource of energy efficiency class	D
Lighting technology	LED
Mains/Non mains connectable	MLS
Directional or non-directional light	DLS
Color tunable light source	Yes
Type of color temperature	STEPS
Flicker	1.0
Stroboscopic effect	0.4

Notes

Flat LED downlight IP54 for surface/recessed mounting and various ceiling cutouts, Power Select, adjustable light color, uniform light emission.

Please, refer to www.radium.de/recycling for notes on disposal of burned-out lamps as well as lamp breakage.

The "lifespan L70" described for LED lamps indicates the number of hours when the luminous flux has decreased to 70% of its initial value.

The optimal field 'info about service life' contains the frame conditions according to standards based on which the specific service life has been determined. So, for example, "12B50, 50Hz" means that the mean service life (B50) has been determined with a 12h switching cycle at mains (frequency 50Hz), "3B50, HF" is based on a 3h switching cycle at electronic control gear (high frequency).

Special features



General notes

The technical design data in accordance with DIN and IEC. The producer does not take any responsibility for damage to persons or property in case of unsuitable operation or handling of the product. Operating data and dimensions are valid within the usual tolerances. Related lamp types (different bases, mains voltages) may be available on request. Sale and delivery are effected in accordance with the Radium Terms of Delivery and Payment valid on the day of conclusion of contract. Packing units offer economical advantages to the purchase and logistic department. Please match your quantity volume accordingly. For orders of a minimum quantity (clefts) with a lamp model the amount lower than the volume of each packaging unit, we will invoice 10 % additional charge per lamp type. Technical changes and terms of delivery are reserved. Manipulation of any kind to packaging or product is not permissible as this will violate Radium brand rights. Furthermore, technical properties of the product can change to its disadvantage or even destruction. Therefore, Radium cannot be responsible for consequential damages.

® = Registered trademark

Subject to change without notice. Errors and omissions excepted.

LED Downlight Star Multi IP54
50-180 18W PS CCT

Radium

All technical data without guarantee.