

LED Moisture-proof Luminaire Star IP66

1500/840 PS SR THRW

Radium

Product Datasheet Date: 21.06.2026

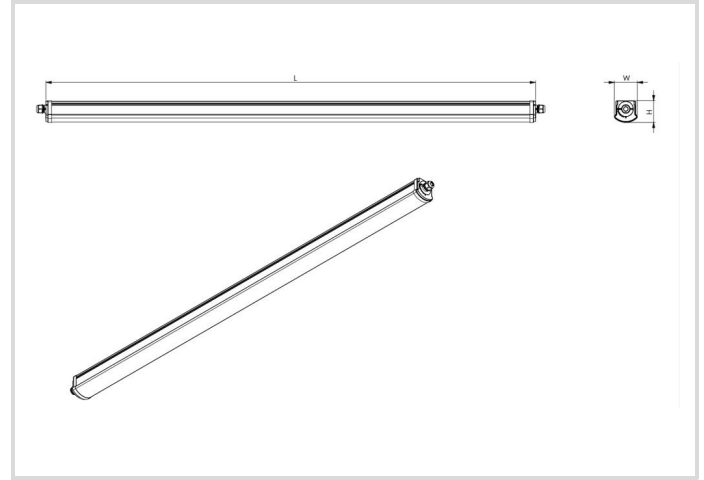

4000K



General Data

Article No.	DAPA5110
Code	DP S 1500/840 PS SR THRW IP66
Product EAN	4003556015401
Box quantity (pcs.)	9
EAN Box	4003556415409
Gross weight of box in kg	13.6
Length of box in m	1.6
Width of box in m	0.245
Height of box in m	0.245
Product weight	1200 g
Product status	● Active

Electric Parameters

Factory setting wattage	50.0 W
Max. system power	50.0 W
Power factor	0.9
Nominal voltage	220-240 V
Voltage type	AC

Electric Parameters

Factory setting lamp current	222 mA
Nominal current	168-222 mA
Inrush current	12.3 A
Mains frequency	50/60 Hz
Dimming with push-button	No

Light Application Parameters

Luminous flux adjustable	Positions
Factory setting luminous flux	7500 lm
Luminous flux	7500 lm
Rated luminous flux according to IEC 62722-2-1	7500 lm
Luminous flux @4000K	5700-7500 lm
Beam angle adjustable	No
Beam angle	130 °
Unified Glare Ratio (UGR)	26
Efficacy / Luminous efficiency	150 lm/W
Colour of light adjustable	No
Colour of light	White
Color temperature	4000 K
Color coordinate X	0.380
Color coordinate Y	0.380
Color rendering index	≥ 80
Color Stability	≤ 6 sdcn
Light sharing	Symmetric
With light sensor	No

Service Life

Lifetime L70B50	75000 h
Life L80B10	75000 h
No. switching cycles	≥ 100.000
Guarantee	5

Specification

Length	1558 mm
Height/depth	67 mm
Width	71 mm

LED Moisture-proof Luminaire Star IP66

1500/840 PS SR THRW

Radium

Specification

Impact strength	IK08
Photobiological safety according to EN 62471	RG0
Material	PC
Housing material	Plastic
Material cover	Plastic matt/satinized
Housing colour	White
With light source	Yes

Notes on Operation

Degree of protection (IP)	IP66
Protection class	II
Connection type	Push-in clamp
Type of wiring	Suitable for through wiring
Max. number of luminaires per B10 circuit breaker	15
Max. number of luminaires per B16 circuit breaker	15
Filament test according to IEC 60695-2-11	750 °C - 30 s
Type of control gear	LED operating device voltage-controlled
With light sensor	No
With movement sensor	No
Emergency power supply integrated	No

Information especially for EPREL

Contains a lightsource of energy efficiency class	D
Mains/Non mains connectable	MLS
Color tunable light source	No
Flickering value Pst LM	1
Stroboscope effect value SVM	0.4
EPREL ID number	2692999

Notes

Robust design for damp/dusty environments. Easy installation, through-wiring, power select, homogeneous light, wide beam, not dimmable.

Please, refer to www.radium.de/recycling for notes on disposal of burned-out lamps as well as lamp breakage.

The "lifespan L70" described for LED lamps indicates the number of hours when the luminous flux has decreased to 70% of its initial value.

The optimal field 'info about service life' contains the frame conditions according to standards based on which the specific service life has been determined. So, for example, "12B50, 50Hz" means that the mean service life (B50) has been determined with a 12h switching cycle at mains (frequency 50Hz), "3B50, HF" is based on a 3h switching cycle at electronic control gear (high frequency).

LED Moisture-proof Luminaire Star IP66

1500/840 PS SR THRW

Radium

Spectrum

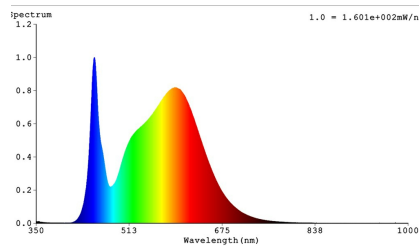

Special features



General notes

The technical design data in accordance with DIN and IEC. The producer does not take any responsibility for damage to persons or property in case of unsuitable operation or handling of the product. Operating data and dimensions are valid within the usual tolerances. Related lamp types (different bases, mains voltages) may be available on request. Sale and delivery are effected in accordance with the Radium Terms of Delivery and Payment valid on the day of conclusion of contract. Packing units offer economical advantages to the purchase and logistic department. Please match your quantity volume accordingly. For orders of a minimum quantity (clefts) with a lamp model the amount lower than the volume of each packaging unit, we will invoice 10 % additional charge per lamp type. Technical changes and terms of delivery are reserved. Manipulation of any kind to packaging or product is not permissible as this will violate Radium brand rights. Furthermore, technical properties of the product can change to its disadvantage or even destruction. Therefore, Radium cannot be responsible for consequential damages.

® = Registered trademark

Subject to change without notice. Errors and omissions excepted.

All technical data without guarantee.