

Metal halide lamp with quartz burner

HRI-TS 150W/WDL/230/XLN/RX7S

Radium

Product Datasheet Date: 04.05.2026

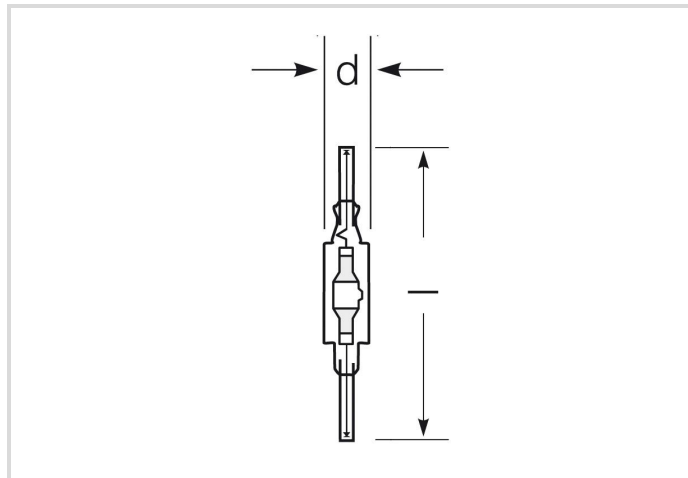

A

G

12000

3100K

12 000h

General Data

Article No.	32419665
Code	HRI-TS 150W/WDL/230/XLN/RX7S
Product EAN	4008597196652
Box quantity (pcs.)	12
EAN Box	4008597596650
Gross weight of box in kg	0.498
Length of box in m	0.149
Width of box in m	0.116
Height of box in m	0.154
Product weight	22 g
Product status	● Inactive

Electric Parameters

Wattage	154.7 W
Lamp nominal wattage	150 W
Energy consumption kWh/1000h	155
Lamp voltage	95 V
Lamp voltage	95 V

Electric Parameters

Mains voltage	230 V
Ignition voltage	4.0 up to 5.0
Hot restrike voltage	35 kV
Lamp's nominal current	1.8 A
Nominal choke current	1.8 A
Compensation capacitor for 50Hz operation	20 µF
dimnable	No

Light Application Parameters

Luminous flux	12000 lm
Rated lamp luminous flux	12000 lm
Efficacy	78 lm/W
Total mains efficacy	80 lm/W
Light colour	warm white de luxe
Colour temperature	3100 K
Color coordinate X	0,427
Color coordinate Y	0,398
Color rendering index	70
Lumen maintenance at 2000h	0.79
Lumen maintenance at 4000h	0.75
Lumen maintenance at 6000h	0.67
Lumen maintenance at 8000h	0.60
Lumen maintenance at 12000h	0.50

Service Life

Average life	12000 h
Lamp survival factor at 2000h	0.95
Lamp survival factor at 4000h	0.90
Lamp survival factor at 6000h	0.85
Lamp survival factor at 8000h	0.80
Lamp survival factor at 12000h	0.50

Specification

Energylabel notice	current label, with EPREL registration
Energylabel (G -> A)	G
Energylabel (E -> A++)	A

Metal halide lamp with quartz burner

HRI-TS 150W/WDL/230/XLN/RX7S

Radium

Specification

Diameter	23 mm
Length	135 mm
Total length max.	135 mm
Contact distance I	132 mm
Burning position	p45
Mercury content	16.7 mg
Lamp shape	Tube, double-ended
Model	Clear
Base	RX7s-24
Colour	White

Notes on Operation

Burning position	p45
------------------	-----

Information especially for EPREL

Energylabel notice	current label, with EPREL registration
Lighting technology	MH
EPREL ID number	541426

Miscellaneous

EU Directive	TIM
Similar products	32419661, 32420042, 32419475

Notes

Compact MH lamp with quartz burner, tubular bulb clear, light colour WDL, base RX7s. Operation in enclosed luminaire, with ballast and ignitor.

Please, refer to www.radium.de/recycling for notes on disposal of burned-out lamps as well as lamp breakage.

The "lifespan L70" described for LED lamps indicates the number of hours when the luminous flux has decreased to 70% of its initial value.

The optimal field 'info about service life' contains the frame conditions according to standards based on which the specific service life has been determined. So, for example, "12B50, 50Hz" means that the mean service life (B50) has been determined with a 12h switching cycle at mains (frequency 50Hz), "3B50, HF" is based on a 3h switching cycle at electronic control gear (high frequency).

Base



R7s
IEC/EN 60061-1
sheet 7004-92A-4

Spectrum

Natural daylight is a mixture of direct sunlight and the light of the sky. Therefore, its spectral composition changes permanently due to the changing

Metal halide lamp with quartz burner

HRI-TS 150W/WDL/230/XLN/RX7S

time of day. The standardised light classification D65 corresponds to a daylight with a colour temperature of approximately 6500 K. Every discharge lamp type has got an individual spectral power distribution according to its chemical filling. From this result important properties light colour or colour rendering.

Should the spectral lines be very close together the lamp presumably has got a very good colour rendering index, so, Ra might be near 100. Does the spectrum rather look like single lines or frayed out the colour rendering of the lamp will probably be not as good.

If number and height of the spectral lines within the blue range (around 400 nm) prevails it might be a lamp with a rather cold light colour like for example daylight. On the other hand, should the red (around 700 nm) or the red and yellow (around 600 nm) range be dominant one can assume that the lamp will be a rather warm light colour like WDL.

After the lamp start a metal halide lamp needs about 2-4 minutes time to reach its full luminous flux, all colours in the spectrum are within the discharge arc then.

Visible region from 380 to 780 nm; height of graph corresponding with relative spectral emission (400mW/klm) per 10nm.

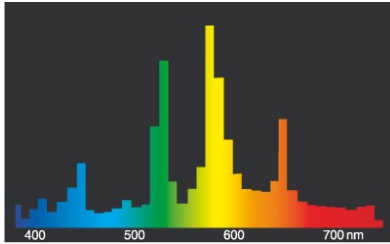

HRI.../WDL

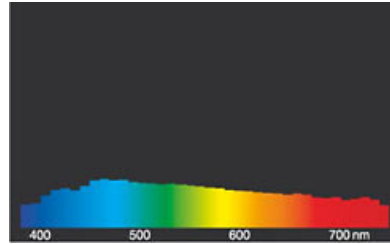

daylight(D 65)

Circuit diagram(s)

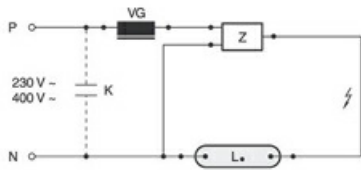

Standard circuit HID with external ignitor

Key:

L. = lamp

VG = electromagnetic ballast (KVG/VVG)

P = phase

N = zero potential

K = p. f. correction capacitor

Z = ignitor

The required control gear (here ignitor and ballast) for the lamps operation is usually mounted in the suitable luminaire in an appropriate electric circuit. Changes of any kind are to be conducted by qualified and specialised staff, only. Thus, this circuit example is to be understood merely as a technical background information for interested users.

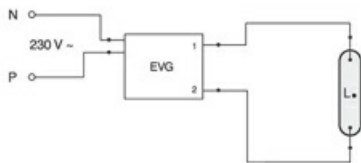

ECG-operation

Key:

L. = lamp

EVG = electronic ballast

P = phase

N = zero potential

The required control gear (here electronic ballast) for the lamps operation is usually mounted in the suitable luminaire in an appropriate electric circuit. Changes of any kind are to be conducted by qualified and specialised staff, only. Thus, this circuit example is to be understood merely as a technical background information for interested users.

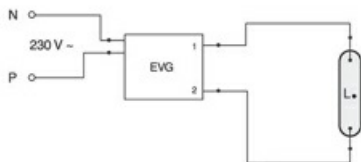

ECG-operation

Key:

L. = lamp

EVG = electronic ballast

P = phase

N = zero potential

The required control gear (here electronic ballast) for the lamps operation is usually mounted in the suitable luminaire in an appropriate electric circuit. Changes of any kind are to be conducted by qualified and specialised staff, only. Thus, this circuit example is to be understood merely as a technical background information for interested users.

Metal halide lamp with quartz burner

HRI-TS 150W/WDL/230/XLN/RX7S

Radium

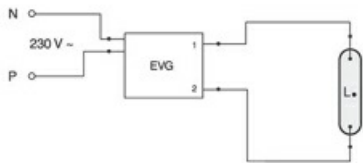

ECG-operation
Key:
L. = lamp
EVG = electronic ballast
P = phase
N = zero potential

The required control gear (here electronic ballast) for the lamps operation is usually mounted in the suitable luminaire in an appropriate electric circuit. Changes of any kind are to be conducted by qualified and specialised staff, only. Thus, this circuit example is to be understood merely as a technical background information for interested users.

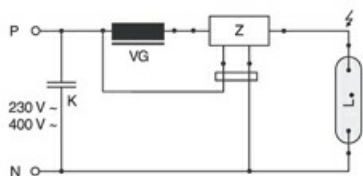

Circuit for 230V-HID-lamps suitable for hot restrike
Key:
L. = lamp
VG = electromagnetic ballast (KVG/VVG)
P = phase
N = zero potential
K = p. f. correction capacitor
Z = ignitor

The required control gear (here ignitor and ballast) for the lamps operation is usually mounted in the suitable luminaire in an appropriate electric circuit. Changes of any kind are to be conducted by qualified and specialised staff, only. Thus, this circuit example is to be understood merely as a technical background information for interested users.

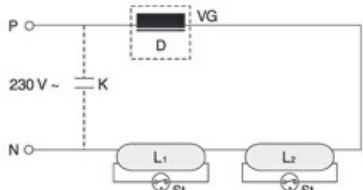

ECG-operation with additional ignitor
Key:
L. = lamp
EVG = electronic ballast
P = phase
N = zero potential
Z = ignitor

The required control gear (here ignitor and electronic ballast) for the lamps operation is usually mounted in the suitable luminaire in an appropriate electric circuit. Changes of any kind are to be conducted by qualified and specialised staff, only. Thus, this circuit example is to be understood merely as a technical background information for interested users.

Special features



General notes

The technical design data in accordance with DIN and IEC. The producer does not take any responsibility for damage to persons or property in case of unsuitable operation or handling of the product. Operating data and dimensions are valid within the usual tolerances. Related lamp types (different bases, mains voltages) may be available on request. Sale and delivery are effected in accordance with the Radium Terms of Delivery and Payment valid on the day of conclusion of contract. Packing units offer economical advantages to the purchase and logistic department. Please match your quantity volume accordingly. For orders of a minimum quantity (clefts) with a lamp model the amount lower than the volume of each packaging unit, we will invoice 10 % additional charge per lamp type. Technical changes and terms of delivery are reserved. Manipulation of any kind to packaging or product is not permissible as this will violate Radium brand rights. Furthermore, technical properties of the product can change to its disadvantage or even destruction. Therefore, Radium cannot be responsible for consequential damages.

® = Registered trademark

Subject to change without notice. Errors and omissions excepted.

All technical data without guarantee.