

Aluminiumprofile black and Cover frosted

SET SMALL U FLAT SQUARE 17/18 BLACK 1M

Radium

Product Datasheet Date: 20.05.2026

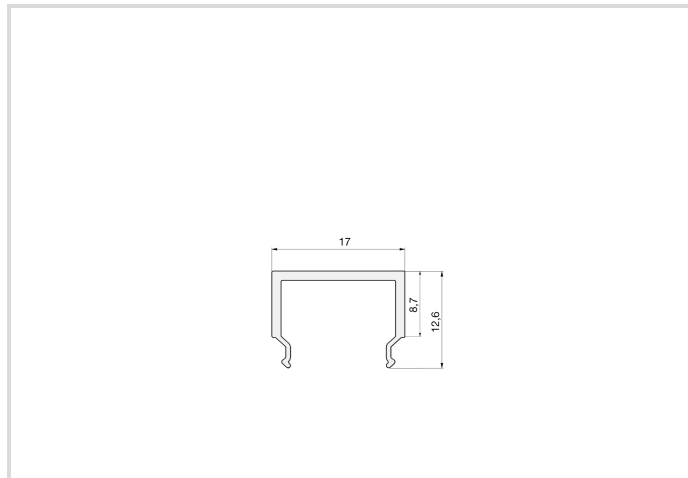

General Data

Artikel Nr.	FXZA4546
Bestellzeichen	SET SMALL U FLAT SQUARE 17/18 BLACK 1M
EAN-Faltschachtel	4003556014244
Versandeinheit in Stk.	10
EAN Umkarton (Versandeinheit)	4003556414242
Brutto-Gewicht Versandeinheit in kg	2.508
Länge Versandeinheit in m	1.085
Breite Versandeinheit in m	0.108
Höhe Versandeinheit in m	0.1
Product weight	200 g
Produktstatus	● Aktiv

Specification

Type of accessory/spare part	Profile
Length	1 m
Width	17.3 mm
Product shape	U profile flat

Notes on Operation

Suitable Accessories	ZTPA4576, ZTPA2621
----------------------	--------------------

Miscellaneous

Similar products	FXZA4547, FXZA4542, FXZA4548
------------------	------------------------------

Aluminiumprofile black and Cover frosted

SET SMALL U FLAT SQUARE 17/18 BLACK 1M

Radium

Notes

1m set of high frosted cover + black aluminum profile in a flat design, optimal cooling + protection of the LED strip, versatile mounting options.

Please, refer to www.radium.de/recycling for notes on disposal of burned-out lamps as well as lamp breakage.

The "lifespan L70" described for LED lamps indicates the number of hours when the luminous flux has decreased to 70% of its initial value.

The optimal field 'info about service life' contains the frame conditions according to standards based on which the specific service life has been determined. So, for example, "12B50, 50Hz" means that the mean service life (B50) has been determined with a 12h switching cycle at mains (frequency 50Hz), "3B50, HF" is based on a 3h switching cycle at electronic control gear (high frequency).

Allgemeine Hinweise

The technical design data in accordance with DIN and IEC. The producer does not take any responsibility for damage to persons or property in case of unsuitable operation or handling of the product. Operating data and dimensions are valid within the usual tolerances. Related lamp types (different bases, mains voltages) may be available on request. Sale and delivery are effected in accordance with the Radium Terms of Delivery and Payment valid on the day of conclusion of contract. Packing units offer economical advantages to the purchase and logistic department. Please match your quantity volume accordingly. For orders of a minimum quantity (clefts) with a lamp model the amount lower than the volume of each packaging unit, we will invoice 10 % additional charge per lamp type. Technical changes and terms of delivery are reserved. Manipulation of any kind to packaging or product is not permissible as this will violate Radium brand rights. Furthermore, technical properties of the product can change to its disadvantage or even destruction. Therefore, Radium cannot be responsible for consequential damages.

® = Registered trademark

Subject to change without notice. Errors and omissions excepted.

All technical data without guarantee.