

Cover mat/diffuse for profile S, Cover SMALL

Length 1m

Radium

Product Datasheet Date: 20.05.2026

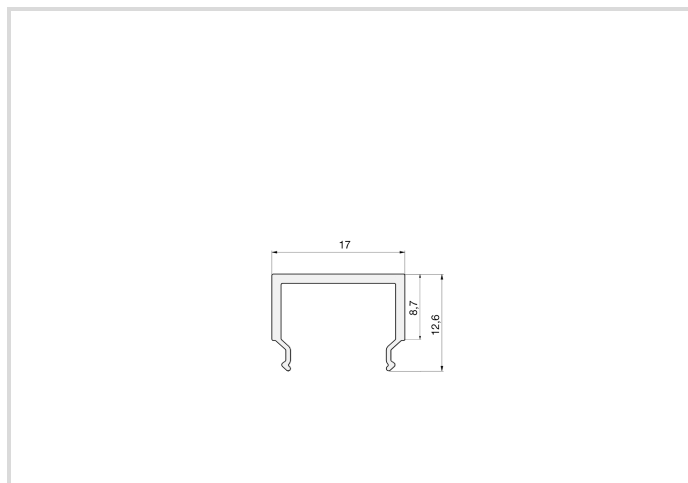

General Data

Artikel Nr.	ZTPA3111
Bestellzeichen	COVER SMALL SQUARE 17/9 C1 1M
EAN-Faltschachtel	4003556010062
Versandereinheit in Stk.	18
EAN Umkarton (Versandereinheit)	4003556410060
Brutto-Gewicht Versandereinheit in kg	1.168
Länge Versandereinheit in m	1.11
Breite Versandereinheit in m	0.07
Höhe Versandereinheit in m	0.53
Product weight	56 g
Produktstatus	● Aktiv

Specification

Type of accessory/spare part	Other
Length	1.01 m
Height	12.6 mm
Width	17 mm
Material	Plastic
no. of LED stripes in profile	1

Miscellaneous

Similar products	ZTPA2581, ZTPA2571
------------------	--------------------

Cover mat/diffuse for profile S, Cover SMALL

Length 1m

Radium

Notes

High-quality, matt white plastic cover for Radium SMALL Profiles.

Please, refer to www.radium.de/recycling for notes on disposal of burned-out lamps as well as lamp breakage.

The "lifespan L70" described for LED lamps indicates the number of hours when the luminous flux has decreased to 70% of its initial value.

The optimal field 'info about service life' contains the frame conditions according to standards based on which the specific service life has been determined. So, for example, "12B50, 50Hz" means that the mean service life (B50) has been determined with a 12h switching cycle at mains (frequency 50Hz), "3B50, HF" is based on a 3h switching cycle at electronic control gear (high frequency).

Allgemeine Hinweise

The technical design data in accordance with DIN and IEC. The producer does not take any responsibility for damage to persons or property in case of unsuitable operation or handling of the product. Operating data and dimensions are valid within the usual tolerances. Related lamp types (different bases, mains voltages) may be available on request. Sale and delivery are effected in accordance with the Radium Terms of Delivery and Payment valid on the day of conclusion of contract. Packing units offer economical advantages to the purchase and logistic department. Please match your quantity volume accordingly. For orders of a minimum quantity (clefts) with a lamp model the amount lower than the volume of each packaging unit, we will invoice 10 % additional charge per lamp type. Technical changes and terms of delivery are reserved. Manipulation of any kind to packaging or product is not permissible as this will violate Radium brand rights. Furthermore, technical properties of the product can change to its disadvantage or even destruction. Therefore, Radium cannot be responsible for consequential damages.

® = Registered trademark

Subject to change without notice. Errors and omissions excepted.

All technical data without guarantee.